

FLUKE®

Biomedical

SPOT Light

SpO₂ Functional Tester

Users Manual

PN 4151274

February 2012, Rev. 1

© 2012 Fluke Corporation. All rights reserved. Printed in USA. Specifications are subject to change without notice.
All product names are trademarks of their respective companies.

Warranty and Product Support

Fluke Biomedical warrants this instrument against defects in materials and workmanship for two years from the date of original purchase. You will be charged our customary fee for such calibration. During the warranty period, we will repair or at our option replace, at no charge, a product that proves to be defective, provided you return the product, shipping prepaid, to Fluke Biomedical. This warranty covers the original purchaser only and is not transferable. The warranty does not apply if the product has been damaged by accident or misuse or has been serviced or modified by anyone other than an authorized Fluke Biomedical service facility. NO OTHER WARRANTIES, SUCH AS FITNESS FOR A PARTICULAR PURPOSE, ARE EXPRESSED OR IMPLIED. FLUKE SHALL NOT BE LIABLE FOR ANY SPECIAL, INDIRECT, INCIDENTAL OR CONSEQUENTIAL DAMAGES OR LOSSES, INCLUDING LOSS OF DATA, ARISING FROM ANY CAUSE OR THEORY.

This warranty covers only serialized products and their accessory items that bear a distinct serial number tag. Recalibration of instruments is not covered under the warranty.

This warranty gives you specific legal rights and you may also have other rights that vary in different jurisdictions. Since some jurisdictions do not allow the exclusion or limitation of an implied warranty or of incidental or consequential damages, this limitation of liability may not apply to you. If any provision of this warranty is held invalid or unenforceable by a court or other decision-maker of competent jurisdiction, such holding will not affect the validity or enforceability of any other provision.

Notices

All Rights Reserved

© Copyright 2012, Fluke Biomedical. No part of this publication may be reproduced, transmitted, transcribed, stored in a retrieval system, or translated into any language without the written permission of Fluke Biomedical.

Copyright Release

Fluke Biomedical agrees to a limited copyright release that allows you to reproduce manuals and other printed materials for use in service training programs and other technical publications. If you would like other reproductions or distributions, submit a written request to Fluke Biomedical.

Unpacking and Inspection

Follow standard receiving practices upon receipt of the instrument. Check the shipping carton for damage. If damage is found, stop unpacking the instrument. Notify the carrier and ask for an agent to be present while the instrument is unpacked. There are no special unpacking instructions, but be careful not to damage the instrument when unpacking it. Inspect the instrument for physical damage such as bent or broken parts, dents, or scratches.

Technical Support

Claims

Our routine method of shipment is via common carrier, FOB origin. Upon delivery, if physical damage is found, retain all packing materials in their original condition and contact the carrier immediately to file a claim. If the instrument is delivered in good physical condition but does not operate within specifications, or if there are any other problems not caused by shipping damage, please contact Fluke Biomedical or your local sales representative.

Returns and Repairs

Return Procedure

All items being returned (including all warranty-claim shipments) must be sent freight-prepaid to our factory location. When you return an instrument to Fluke Biomedical, we recommend using United Parcel Service, Federal Express, or Air Parcel Post. We also recommend that you insure your shipment for its actual replacement cost. Fluke Biomedical will not be responsible for lost shipments or instruments that are received in damaged condition due to improper packaging or handling.

Use the original carton and packaging material for shipment. If they are not available, we recommend the following guide for repackaging:

- Use a double-walled carton of sufficient strength for the weight being shipped.
- Use heavy paper or cardboard to protect all instrument surfaces. Use nonabrasive material around all projecting parts.
- Use at least four inches of tightly packed, industry-approved, shock-absorbent material around the instrument.

Returns for partial refund/credit:

Every product returned for refund/credit must be accompanied by a Return Material Authorization (RMA) number, obtained from our Order Entry Group

Repair and calibration:

Certification

This instrument was thoroughly tested and inspected. It was found to meet Fluke Biomedical's manufacturing specifications when it was shipped from the factory. Calibration measurements are traceable to the National Institute of Standards and Technology (NIST). Devices for which there are no NIST calibration standards are measured against in-house performance standards using accepted test procedures.

WARNING

Unauthorized user modifications or application beyond the published specifications may result in electrical shock hazards or improper operation. Fluke Biomedical will not be responsible for any injuries sustained due to unauthorized equipment modifications.

Restrictions and Liabilities

Information in this document is subject to change and does not represent a commitment by Fluke Biomedical. Changes made to the information in this document will be incorporated in new editions of the publication. No responsibility is assumed by Fluke Biomedical for the use or reliability of software or equipment that is not supplied by Fluke Biomedical, or by its affiliated dealers.

Manufacturing Location

The SPOT Light SpO2 Functional Tester is manufactured at Fluke Biomedical, 6920 Seaway Blvd., Everett, WA, U.S.A.

Table of Contents

Title	Page
Introduction	1
Intended Use	2
Safety Information	2
Unpack the Product.....	3
Instrument Familiarization	4
Accessories.....	5
How to Turn On the Product.....	6
How to Use the Product	6
SpO2 Sensor Placement	6
How to Set Test Parameters	8
How to Set Custom Tests.....	9
Maintenance.....	10
How to Clean the Product.....	11
Battery Maintenance.....	11
How to Charge the Battery	11

Battery Removal.....	13
General Specifications.....	14
Detailed Specifications	14
Oximeter SpO ₂ Optical Emitter and Detector	14

List of Tables

Table	Title	Page
1.	Symbols.....	2
2.	Product Controls and Connections.....	4
3.	Standard Accessories	5
4.	Optional Accessories.....	5
5.	Test Parameters.....	8

List of Figures

Figure	Title	Page
1.	Product Controls and Connections	4
2.	Power-Up Screen	6
3.	Main Screen	6
4.	Oximeter Sensor Placement.....	7
5.	SpO2 Parameter Change	9
6.	External Battery Charging Connections	12
7.	Battery Removal	13

SpO2 Functional Tester

Introduction

Warning







To prevent possible electrical shock, fire, or personal injury, read all “safety information” before you use the Product.

The Fluke Biomedical SPOT Light SpO2 Functional Tester (the Product) is a compact, portable, functional tester used to measure the performance of SpO2 monitors (pulse oximeters).

The Product uses light detection and emission to do tests. The tests examine the electronics of the pulse oximeter and the sensor.

Table 1 is a list of the symbols used on the Product and in this manual.

Table 1. Symbols

Symbol	Description
	Important information. Refer to manual.
	Hazardous voltage.
	Conforms to relevant Canadian and US standards.
	Conforms to relevant Australian EMC requirements.
	Conforms to European Union directives.
	Do not dispose of this product as unsorted municipal waste. Go to Fluke's website for recycling information.

Intended Use

The Product is intended to be used to test and verify the basic operation of patient monitoring devices or systems used to monitor SpO2. Additionally, the Product provides an optical signal to verify the electronics inside the pulse oximeter sensor are functional.

The intended user is a trained biomedical equipment technician who performs periodic preventative maintenance checks on patient monitors in service. Users can be associated with hospitals, clinics, original

equipment manufacturers and independent service companies that repair and service medical equipment. The end user is an individual, trained in medical instrumentation technology.

This Product is not intended for use on patients, or to test devices while connected to patients. This Product is not intended to be used to calibrate medical equipment.

Safety Information

A **Warning** identifies conditions and procedures that are dangerous to the user. A **Caution** identifies conditions and procedures that can cause damage to the Product or the equipment under test.

Warning

To prevent possible electrical shock, fire, or personal injury, follow these guidelines:

- **Do not connect the Product to a patient or equipment connected to a patient. The Product is intended for equipment evaluation only and should never be used in diagnostics, treatment, or any other capacity where the Product would come in contact with a patient.**
- **Use the Product only as specified, or the protection supplied by the Product can be compromised.**

- **Replace the batteries when the low battery indicator shows to prevent incorrect measurements.**
- **Carefully read all instructions.**
- **Do not use the Product around explosive gas, vapor, or in damp or wet environments.**
- **Do not use, and disable the Product if it is damaged.**
- **Do not use the Product if it operates incorrectly.**
- **Use only current probes, test leads, and adapters supplied with the Product.**

⚠ Caution

The pulse oximeter component of the device is not intended to validate the SpO2 accuracy of pulse oximeter equipment.

This device is not intended to confirm the SpO2 accuracy of the calibration curve of the pulse oximeter monitor or to assess the optical characteristics of representative pulse oximeter sensors to determine their proper calibration.

Not all functional testers and pulse oximeter equipment are compatible. Functional testers can vary in pulse methods, pulse contours, and amplitude. A functional tester might not accurately reproduce the calibration of the pulse oximeter equipment and can yield different results between pulse oximeter equipment.

Unpack the Product

Carefully unpack all items from the box and check that you have these items:

- SPOT Light
- Users Manual
- Carrying Case
- Power Cord
- AC/DC Power Supply

Instrument Familiarization

Table 2 is a list of Product controls and connections shown in Figure 1.

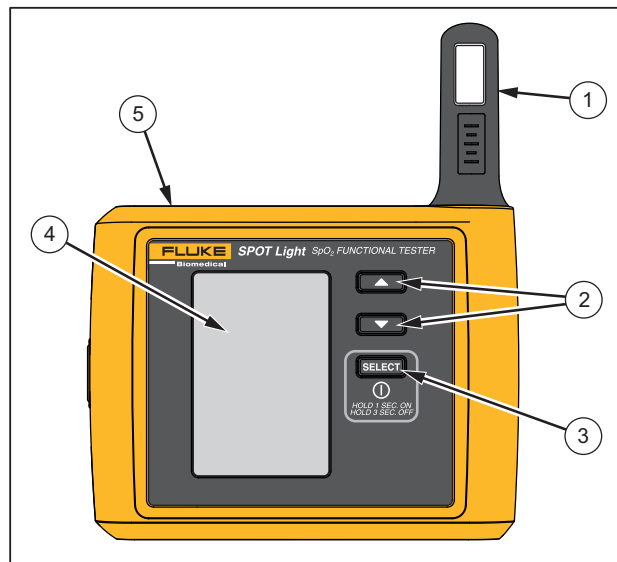

gvh003.eps

Figure 1. Product Controls and Connections

Table 2. Product Controls and Connections

Item	Description
1	SpO2 Artificial Finger
2	Scroll Up and Down Buttons
3	Select Button
4	LCD Display
5	Mini B USB Device Port (Service use only)

Accessories

Available Product accessories are shown in Table 3 and 4.

Table 3. Standard Accessories

Item		Fluke Biomedical Part Number
SPOT Light Users Manual		4151274
AC/DC Power Supply		3978380
AC Power Cord	US	284174
	Schuko	769422
	UK	769455
	Japan	284174
	Australia/China	658641
	Brazil ^[1]	3841347
Carrying Case		4026799
[1] Product shipped to Brazil also includes a US power cord.		

Table 4. Optional Accessories

Item		Fluke Biomedical Part Number
Battery Pack		4026823

How to Turn On the Product

Push **SELECT** for one second to turn on the Product. The screen shown in Figure 2 is the power-up screen. Push **SELECT** and hold for 3 seconds to turn off the Product.



Figure 2. Power-Up Screen

Note

Firmware version shown is for illustration only. The version shown on your Product could be different.

When the self test is complete and no errors are sensed, the screen shown in Figure 3 shows in the display.

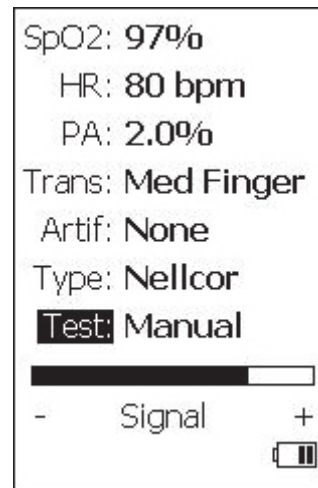

Figure 3. Main Screen

gvh004.jpg

How to Use the Product

All Product tests are set through the controls on the main screen. As each parameter is set, the test value changes immediately.

SpO2 Sensor Placement

Put the SpO2 sensor on the artificial finger as shown in Figure 4.

SpO2 Functional Tester

How to Use the Product

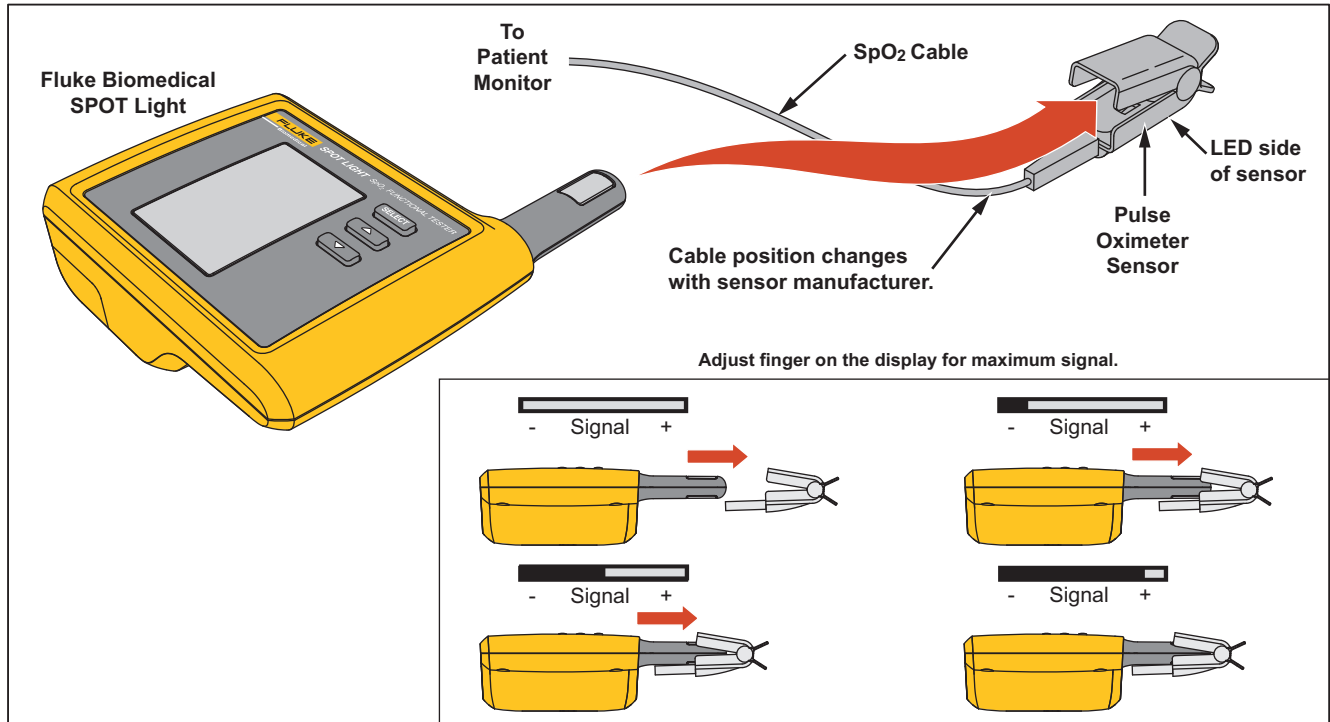

Figure 4. Oximeter Sensor Placement

gvh006.eps

Put the sensor with the LEDs on the bottom of the artificial finger. While you put the sensor on the artifact finger, monitor the signal indicator along the bottom of the Product display. Adjust the sensor on the finger for maximum signal strength.

Note

Cable position changes with sensor manufacturer

How to Set Test Parameters





When you turn on the Product, all parameters are set to their default values. To change a parameter value, push  or  to move the highlight to a parameter that you need to change. Push **SELECT** to move the highlight to the value of the parameter. Push  or  to scroll through the values. With the correct parameter value shown in the display, push **SELECT** to set the parameter. Table 5 is a list of all parameters and their values.

Table 5. Test Parameters

Parameter	Values*
SpO2	80%, 85%, 90%, 95%, 97% , 98%, 99%, 100%
HR (Heart Rate)	30, 60, 80 , 100, 120, 150, 180, and 240 BPM
PA (Pulse Amplitude)	0.2%, 2.0% , and 10%
Transmission	LG (Large), Med (Medium) , and Sm (Small) finger
Artifact	None , Respiration: 2.5%, Ambient light: 50 or 60 Hz
Type	Nonin, Masimo, Nellcor , Nihon Kohden, Mindray, GE-Ohmeda, Philips/HP, and BCI
Test	Manual , Custom 1, Custom 2, and Custom 3
* Default values are in bold type.	

As one example, to change the SpO2 value to 98 %:

1. Push **▲** or **▼** to move the highlight to **SpO2:** in the display.
2. Push **SELECT**. The highlight moves to the SpO2 parameter value as shown in Figure 5.

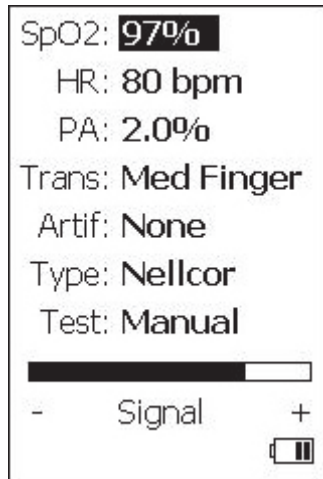

Figure 5. SpO2 Parameter Change

3. Push **▲** or **▼** to scroll through the SpO2 parameter values until **98%** shows in the display.

Note

As each parameter is set, the artificial finger outputs the new parameter value immediately.

4. Push **SELECT**. The highlight moves back to **SpO2:** and the value stays set at 98 %.

How to Set Custom Tests

When the **Test** parameter is set to **Manual**, no parameter values are stored. A maximum of three custom tests can be stored in the Product.

To set up a custom test:

1. Push **▲** or **▼** to move the highlight to **Test:** in the display.
2. Push **SELECT**. The highlight moves to the Test parameter.
3. Push **▲** or **▼** to scroll through the test values. Stop when Custom 1, Custom 2, or Custom 3 shows in the display.
4. Push **SELECT**.

When the **Test** parameter is set to **Custom 1**, **Custom 2**, or **Custom 3**, each parameter you change becomes a new value for that custom test.

gvh005.jpg

Maintenance

The Product is an SpO2 functional tester. Try to prevent mechanical abuse that could change the test values. The Product has no internal user-serviceable parts.

⚠ Warning

For safe operation and maintenance of the Product and to prevent personal injury:

- **Repair the Product before use if the battery leaks.**
- **Remove batteries to prevent battery leakage and damage to the Product if it is not used for an extended period.**
- **Connect the battery charger to the mains power outlet before the Product.**
- **Use only Fluke approved power adapters to charge the battery.**
- **Do not short the battery terminals together.**
- **Do not keep cells or batteries in a container where the terminals can be shorted.**
- **Keep cells and battery packs clean and dry. Clean dirty connectors with a dry, clean cloth.**
- **Batteries contain hazardous chemicals that can cause burns or explode. If exposure to chemicals occurs, clean with water and get medical aid.**
- **Do not put battery cells and battery packs near heat or fire. Do not put in sunlight.**
- **Do not disassemble or crush battery cells and battery packs.**
- **Have an approved technician repair the Product.**
- **Use only specified replacement parts.**
- **Remove the input signals before you clean the Product.**
- **Connect factory supplied three-conductor mains power cord to a grounded power outlet.**
- **Do not use a two-conductor adapter or extension cord.**

How to Clean the Product

⚠ Caution

Do not put fluid onto the Product surface. Fluid seepage into the electrical circuitry may cause the Product to fail.

Do not use spray cleaners on the Product. This action can force the cleaning fluid into the Product and damage electronic components.

Clean the Product occasionally with a damp cloth and mild detergent. Try to prevent the entrance of liquids.

Battery Maintenance

For peak battery performance, charge the Product to maximum charge a minimum of one time each month. If the Product is not to be used for more than a month, keep it connected to the charger.

Note

To get the specified performance, use the specified battery charger that comes with this Product.

When the battery gets low, a low battery message shows in the display.

How to Charge the Battery

The battery charge level is shown in the lower-right corner of the display when the battery pack is installed in the Product. If the battery charges,  shows in the

lower-right corner of the display. With the AC/DC power supply removed from the Product, the battery icon shows the charge level.

The battery can be charged while it is in or out of the Product. The charge rate is slower when the Product is energized and the battery charger is on. To charge the battery:

1. As shown in Figure 6, connect the ac/dc power supply to the power connector on the battery pack.
2. Connect the ac/dc power supply to a power source. The battery charge LED on the battery pack shows red or green when the ac/dc power supply is connected to the battery pack. When the LED is green, the battery is charged.

When you have two or more battery packs, you can charge one battery externally while you use the other to energize the Product.

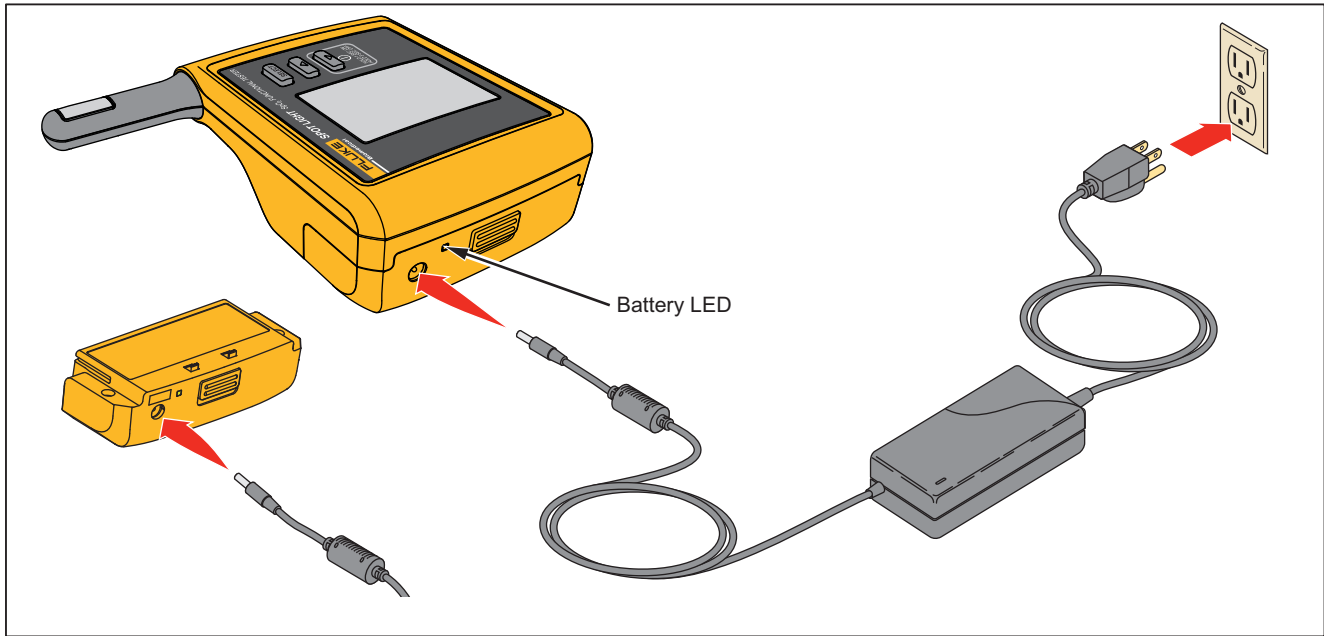

Figure 6. External Battery Charger Connections

gvh002.eps

Battery Removal

The battery pack is easy to remove and replace. To remove the battery pack:

1. Push down on the battery pack latch as shown in Figure 7.
2. Pull the battery pack from the Product.

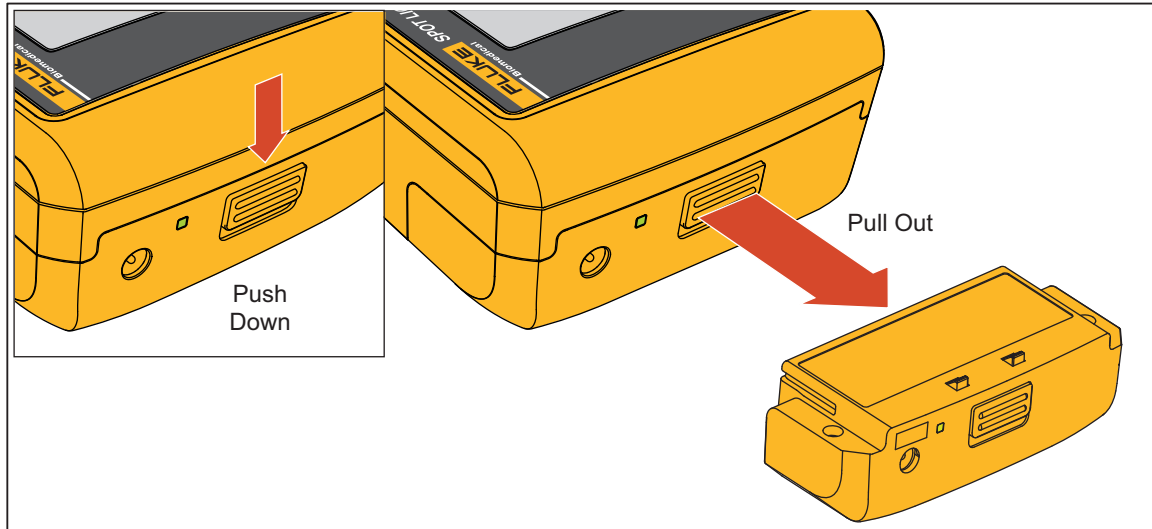

gvh023.eps

Figure 7. Battery Removal

To put the battery pack into the Product, align the battery pack with the guides on the Product and push it into the Product until the latch locks.

General Specifications

Temperature

Operating	10 °C to 40 °C (50 °F to 104 °F)
Storage	-20 °C to +60 °C (-4 °F to +140 °F)

Humidity..... 10 % to 90 % non-condensing

Altitude..... 3,000 m (9,843 ft)

Size (W x H x D)..... 12.53 cm x 14.86 cm x 4.77 cm (4.94 in x 5.85 in x 1.88 in)

Display..... LCD Monochrome display

Communication (USB Device Virtual COM Port) .. Mini B connector for service upload of firmware

Power..... Lithium-Ion rechargeable, 3.7 V, 10.75 Wh battery, 2900 mAh

Battery Charger..... 100 V to 240 V, 50/60 Hz input, 6 V/2.5 A output. For best performance, the battery charger must be connected to a properly grounded ac receptacle.

Battery Life..... 10 hours (minimum)

Weight..... 0.29 kg (0.7 lb)

Safety Standards..... EN/IEC 61010-1:2001

Certifications



Electromagnetic Compatibility (EMC)..... EN 61326-1:2006

Detailed Specifications

Oximeter SpO₂ Optical Emitter and Detector

%O₂

O₂ Saturations..... 80 %, 85 %, 90 %, 95 %, 97 %, 98 %, 99 %, and 100 %

Accuracy

With oximeter manufacturer's R-curve

Saturation within UUT specific range..... ±(1 count + specified accuracy of the UUT)

Saturation outside UUT specific range monotonic with unspecified accuracy

With Fluke Biomedical R-curves

- 95 to 100 %±(3 counts + specified accuracy of the UUT)
- 85 to 90 %±(5 counts + specified accuracy of the UUT)
- 80 %±(7 counts + specified accuracy of the UUT)

Heart Rate

- Rates**.....30, 60, 80, 100, 120, 150, 180, and 240 BPM
- Accuracy.....±1 % of setting

Transmission (Ratio of detector current to LED current, expressed in parts per million (ppm))

- Ratios Large finger (12.00 ppm), medium finger (80.00 ppm), and small finger (300.00 ppm)
- Accuracy..... +50 %/-30 % for compatible monitors, unspecified for others. Selected by finger size and color: large finger, medium finger, small finger.

Pulse Amplitude

- Amplitudes Low (0.2 %), medium (2 %), and high (10 %)

Artifact

- Respiration
 - Size 2.5 % of transmission
 - Rate..... 20 BrPM
- Ambient Light Frequency 50 Hz and 60 Hz

Compatible Manufacturer Products

- With manufacturer R-curve Nellcor, Masimo, Nonin, and Nihon Kohden
- With Fluke Biomedical R-curve Mindray, GE-Ohmeda, Philips/HP, and BCI

